

Project:	
Type:	
Catalog #:	

STANDARD



The 8" Architectural LED series are commercial-grade quality luminaires. These retrofit kits convert nearly any existing 8" incandescent, HID or CFL into LED fixtures. They are upgradeable to the latest and most advanced LED technology. Enjoy energy savings and maintenance-free service with 50,000 hours of life in typical commercial applications.

FEATURES

Installs from below ceiling and secured by tension clips (clips NOT included with the retrofit).

40 Watt available in 3000K.

48 Watt available in 4000K.

Conduit quick-connects

Consistent fixture-to-fixture color temperature within 3 MacAdam Ellipses.

Integral heat sink conducts heat away from LED Light engine.

Driver is accessible from below the ceiling and can be upgraded to accommodate future technology improvements.

Universal 120-277 AC voltage (50/60Hz)

0-10v dimming

Color rendering index ≥ 80 .

Long-life LEDs—up to 50,000 hours.

Operation temp. -30°C – 40°C (-22°F – 104°F).



WARRANTY & LISTINGS

cULus Listed.

Energy Star listed.

Suitable for wet locations (not suitable for coastal/salt water area).

Suitable for damp locations.

RoHS compliant.

5-year warranty of all electronics and housing.

DIMENSIONS

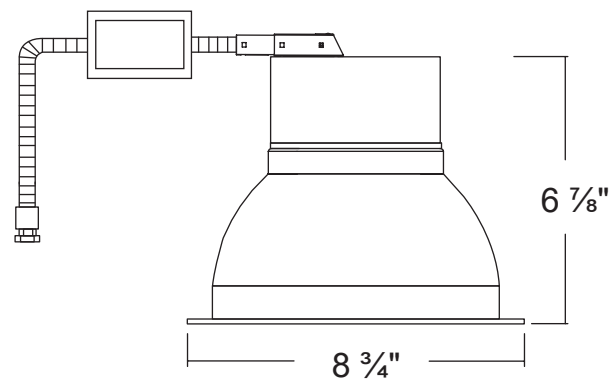

ORDERING INFORMATION

Model	Color Temperature	Luminaire Lumens	Luminaire Watts	Lumens / Watt
BEBRK-LED40ARC8-3K	3000k	3090	40	77
BEBRK-LED48ARC8-4K	4000k	3640	48	76

To place an order, call us at **1.844.459.3711**

Visit us at getbolt.net